

# Gas Sample Probe Series SP®

**SP3000 /xx....**

**⊕ II 1 D/ 2 GD**

**SP3100V /xx.., SP3100 /xx..**

**⊕ II 1 G/ 2 GD or ⊕ II 2 G/ 2 GD**

Instruction Manual

Version 1.00.03





**Dear customer,**

Thank you for buying our product. In this manual you will find all necessary information about this M&C product. The information in the manual is fast and easy to find, so you can start using your M&C product right after you have read the manual.

If you have any question regarding the product or the application, please don't hesitate to contact M&C or your M&C authorized distributor. You will find all the addresses in the appendix of this instruction manual.

For additional information about our products, please go to M&C's website [www.mc-techgroup.com](http://www.mc-techgroup.com). There you can find the data sheets and manuals of our products in German and English.

This instruction manual does not claim completeness and may be subject to technical modifications.

© 02/2021 **M&C Techgroup** Germany GmbH. Reproduction of this document or its content is not allowed without permission from **M&C**.

**SP®** is a registered trade mark.

Version: 1.00.03



## Contents

<b>1</b>	<b>General information</b> .....	<b>5</b>
<b>2</b>	<b>Declaration of conformity</b> .....	<b>6</b>
<b>3</b>	<b>Safety information</b> .....	<b>7</b>
<b>4</b>	<b>Information on use in potentially explosive atmospheres</b> .....	<b>8</b>
<b>5</b>	<b>Warranty</b> .....	<b>8</b>
<b>6</b>	<b>Terms and symbols used in these operating instructions</b> .....	<b>9</b>
<b>7</b>	<b>Application</b> .....	<b>11</b>
<b>8</b>	<b>Description</b> .....	<b>11</b>
8.1	SP3000 (combustible dusts) .....	11
8.2	SP3100 (combustible gases) .....	13
8.3	Sample tubes and pre-filters for the SP3000 .....	14
8.4	Sample tubes, pre-filters and option FW for SP3100 .....	16
<b>9</b>	<b>Options</b> .....	<b>17</b>
9.1	Back purging unit type RS: .....	17
9.2	Option 2-way ball valve /VA .....	17
9.3	Option /3VA feeding of test gas and back purging via 3/2-Way ball valve .....	18
9.4	Ball valve drive MS1 .....	19
9.5	Option /2X Second sample gas outlet on the probe .....	19
9.6	Probe heater .....	19
<b>10</b>	<b>Technical data</b> .....	<b>20</b>
10.1	Maximum surface temperature of the gas sample probe .....	21
<b>11</b>	<b>Receipt and storage</b> .....	<b>21</b>
<b>12</b>	<b>Preparations for installation</b> .....	<b>22</b>
<b>13</b>	<b>Installation</b> .....	<b>24</b>
13.1	Connection of the sample line .....	26
<b>14</b>	<b>Electrical connections</b> .....	<b>28</b>
<b>15</b>	<b>Start-up</b> .....	<b>29</b>
<b>16</b>	<b>Maintenance</b> .....	<b>30</b>
16.1	Replacement of the filter element .....	31
16.2	Replacement of the preliminary filter .....	31
16.3	Blow back Option RS .....	31
16.4	Ball valve VA or 3VA .....	31
16.5	Ball valve drive MS1 .....	31
16.6	Cleaning of the probe .....	32
<b>17</b>	<b>Shutdown</b> .....	<b>32</b>
<b>18</b>	<b>Proper disposal of the device</b> .....	<b>32</b>
<b>19</b>	<b>Appendix</b> .....	<b>33</b>



## List of Figures

Figure 1	Probes SP3000/3100(V) without options with preliminary filter type V20 .....	15
Figure 2	Function schema of option 3/2-way ball valve /3VA .....	18
Figure 3	Schematic drawing of the filter housing cover .....	24
Figure 4	Removal of the filter housing cover .....	25

## List of Tables

Table 1	Marking for gas sampling from processes with combustible dusts .....	12
Table 2	Marking for gas sampling from processes with combustible gases .....	14
Table 3	Possible preliminary filter combinations .....	15
Table 4	Extension tubes .....	15
Table 5	Sample tubes for use with the probe SP3100 and SP3100V.....	16
Table 6	Technical data .....	20
Table 7	Operating parameters .....	23



## Head Office

**M&C TechGroup** Germany GmbH ♦ Rehhecke 79 ♦ 40885 Ratingen ♦ Germany

Telephone: 02102 / 935 - 0

Fax: 02102 / 935 - 111

E - mail: [info@mc-techgroup.com](mailto:info@mc-techgroup.com)

[www.mc-techgroup.com](http://www.mc-techgroup.com)

## 1 GENERAL INFORMATION

The product described in this instruction manual has been built and tested in our production facility.

All M&C products are packed to be shipped safely. To ensure the safe operation and to maintain the safe condition, all instructions and regulations stated in this instruction manual need to be followed. This instruction manual includes all information regarding proper transportation, storage, installation, operation and maintenance of this product by qualified personnel.

Follow all instructions and warnings closely.

Read this manual carefully before commissioning and operating the device. If you have any questions regarding the product or the application, please don't hesitate to contact M&C or your M&C authorized distributor.

## 2 DECLARATION OF CONFORMITY



The product described in this operating manual complies with the following EU directives:

### **ATEX-Directive**

The product described in this manual is produced in accordance with the EU directive for devices and protection systems for appropriate use in hazardous areas 2014/34/EU appendix II. The system of protection depends on the variant of the probe (see tables 1+2).

### **EMV-Instruction**

The requirements of the EU directive 2014/30/EU "Electromagnetic compatibility" are met.

### **Low Voltage Directive**

The requirement of the EU directive 2014/35/EU "Low Voltage Directive" are met.  
The compliance with this EU directive has been examined according to DIN EN 61010.

### **RoHS Directive**

The requirements of the RoHS2 ('Restriction of Hazardous Substances 2') directive 2011/65/EU and its annexes are met.

### **Declaration of conformity**

The EU Declaration of conformity can be downloaded from the **M&C** homepage or directly requested from **M&C**.



### 3 SAFETY INFORMATION

Observe the following fundamental safety precautions when using the device:

- Read these operating instructions carefully before start-up and use of the device! The information and warnings given in these operating instructions must be heeded.
- Pay attention to the certificate of conformity (see appendix).
- Work on electrical equipment may only be carried out by suitably qualified personnel in accordance with valid regulations.
- The requirements of VDE 0100 and its associated standards and regulations must be observed when erecting high-voltage power installations with rated voltages to 1000 V.
- Relevant national and international standards and regulations must be observed when using the device in potentially explosive environments.
- The device must be connected to a mains supply with the same voltage as specified on the rating plate.
- Protection against contact with high electrical voltages:  
The device must be safely isolated from the mains supply before it is opened. The same applies to any connected external control circuits.
- Only use the device within the permissible temperature ranges.
- The device must be installed such that it is protected against weather conditions. Do not expose directly to rain or liquids.
- Installation, maintenance, inspection and repair work may only be carried out by authorised personnel. Such work must be carried out in accordance with applicable rules and regulations.

#### 4 INFORMATION ON USE IN POTENTIALLY EXPLOSIVE ATMOSPHERES

See Table 1 and Table 2 for the markings of the individual variants.

The devices are certified by DEKRA EXAM GmbH.

Detailed information and a copy of the certificate are contained in the appendix to these operating instructions. The devices must be installed and used in accordance with the conditions and installation instructions given in the EC-Type Examination Certificate (see appendix). Only then safe operation in potentially explosive atmospheres is ensured.



Any changes to the standard configuration with unspecified parts or parts not authorised by M&C and repair or service work with unspecified parts lead to an immediate loss of ex-certification.

*- In case of doubt please contact **M&C** directly or your **M&C** franchise dealer.*

#### 5 WARRANTY

In the event of a device failure please contact **M&C** directly or your **M&C** franchise dealer.

The device is covered by a one-year warranty starting from the day of delivery and subject to correct use and our terms and conditions of sale. Wearing parts are not covered by the warranty. The warranty includes free repair at our factory or free replacement of devices sent to us carriage paid and correctly packed.



## 6 TERMS AND SYMBOLS USED IN THESE OPERATING INSTRUCTIONS



**Danger**

The 'Danger' warning sign indicates that death, serious injury and/or significant material damage will be the consequence, if the appropriate precautions should not be taken.



**Warning**

The 'Warning' warning sign indicates that death, serious injury or damage to property may occur if the relevant precautionary measures are not observed.



**Caution**

The 'Caution' warning sign indicates that slight personal injury can occur if the appropriate safety precautions are not observed.

**Caution**

'Caution' indicates that damage to property can occur if the appropriate safety precautions are not observed.

**Attention**

'Attention' indicates that an unintended result or situation can occur if the corresponding information is not taken into account.



**Note**

'Note' indicates important information relating to the product or highlights parts of the documentation for special attention.

**Qualified personnel**

'Qualified personnel' are experts who are familiar with the installation, commissioning, maintenance, and operation of these types of products. The following knowledge is at least required for the work:

- Instructed person in EX-protection
- Trained person in the electrotechnical field
- Detailed knowledge of the manual and the applicable safety regulations



'Ex' indicates important information about the product or about the corresponding parts in the instruction manual, relating to usage in potentially explosive atmospheres.



**High voltages!**

Protect yourself and others against damages which might be caused by high voltages.



**Hot surface!**

Contact may cause burn! Do not touch!



**Corrosive!**

These substances destroy living tissue and equipment upon contact. Do not breathe vapors; avoid contact with skin and eyes.



**Wear protective gloves!**

Working with chemicals, sharp objects or extremely high temperatures requires wearing protective gloves.



**Wear safety glasses!**

Protect your eyes while working with chemicals or sharp objects. Wear safety glasses to avoid getting something in your eyes.



**Wear protective clothes!**

Working with chemicals, sharp objects or extremely high temperatures requires wearing protective clothes.

## 7 APPLICATION

The probes of the type **SP3000** and **SP3100..** are used for continuous gas sampling in dust-laden processes or processes with high temperatures (per Table 7, chapter 10) or high gas moisture. The modular construction of the probes and the variety of possible options guarantee optimum adaptation of the probes to complex process and environmental conditions.

The probes of the type **SP3000** and **SP3100..** are available in both an unheated and an electrically heated version.

The probes may not be used to withdraw gases or gas mixtures that can be explosive even in the absence of air or which change safety-relevant material properties.



The gases or gas mixtures may also not contain any solid particles that could generate ignitable friction or percussion sparks in combination with the materials of the probe.

It is not allowed that during operation potential sources of ignition (e.g. smouldering or burning particles, glowing embers, foreign objects) are brought into the gas sample probe.

## 8 DESCRIPTION

The probes of the type **SP3000** and **SP3100..** have been designed for easy use, long life and uncomplicated service and maintenance.

The internal filter element can be replaced without the need for tools or dismounting of the sample line. When the internal filter element has been removed, both the filter chamber and the sample tube can be cleaned easily.

### 8.1 SP3000 (COMBUSTIBLE DUSTS)

The gas sample probes of the type **SP3000** are suitable for gas sampling from potentially explosive atmospheres in Zone 20 (combustible dusts). The probe housing and all options are designed for use in potentially explosive atmospheres in Zone 1 or 21 (combustible dusts or combustible gases).

The markings can be found in the following table.

The maximum surface temperature of the gas sample probe depends on the process media temperature and the used options (blow back unit RS, ball valve drive MS1 and probe heating HEX4).

The permissible process media temperatures are not allowed to exceed 185 °C [365 °F] at options 2-way-ball-valve VA and 3/2-way-ball-valve 3VA. For variants without these last-mentioned options it is not allowed to exceed 200 °C [392 °F]. The consequential maximum surface temperatures and the derivable temperature classes of the gases are shown in Table 1.



The intended use limits the process media temperature and the choice of options insofar as the maximum surface temperature has to be below the limit temperature of the flammable process dust mentioned in Table 7 resp. it has to correspond to the temperature class of the flammable process gases.

<b>SP3000 for sampling from zone 20 resp. 21 flammable dust</b>				
Type	Ex-marking	Max. process media temperature in °C [°F]	T-class	Max. surface temperature in °C [°F]
<b>SP3000 with graphite sealing</b>				
SP3000	II 1 D / 2 GD	< 80 [176 °F]	T6	85 [185 °F]
	II 1 D / 2 GD	< 95 [203 °F]	T5	100 [212 °F]
	II 1 D / 2 GD	< 130 [266 °F]	T4	135 [275 °F]
	II 1 D / 2 GD	< 195 [383 °F]	T3	200 [392 °F]
	II 1 D / 2 GD	< 200 [392 °F]	T2	205 [401 °F]
<b>Option blow back with solenoid valve</b>				
SP3000/RS	II 1 D / 2 GD	<130 [266 °F]	T4	135 [275 °F]
	II 1 D / 2 GD	<195 [383 °F]	T3	200 [392 °F]
	II 1 D / 2 GD	<200 [392 °F]	T2	205 [401 °F]
<b>Option 2-way ball valve VA</b>				
SP3000/VA (Option MS1 pneumatic drive implies at least temperature class T4.)	II 1 D / 2 GD	<80 [176 °F]	T6	85 [185 °F]
	II 1 D / 2 GD	<95 [203 °F]	T5	100 [212 °F]
	II 1 D / 2 GD	<130 [266 °F]	T4	135 [275 °F]
	II 1 D / 2 GD	<185 [365 °F]	T3	190
<b>Option 3-way ball valve 3VA</b>				
SP3000/3VA (Option MS1 pneumatic drive implies at least temperature class T4.)	II 1 D / 2 GD	<80 [176 °F]	T6	85 [185 °F]
	II 1 D / 2 GD	<95 [203 °F]	T5	100 [212 °F]
	II 1 D / 2 GD	<130 [266 °F]	T4	135 [275 °F]
	II 1 D / 2 GD	<185 [365 °F]	T3	190 [374 °F]
<b>Option blow back RS with solenoid valve and 2-way ball valve VA</b>				
SP3000/RS/VA	II 1 D / 2 GD	<130 [266 °F]	T4	135 [275 °F]
	II 1 D / 2 GD	<185 [365 °F]	T3	190 [374 °F]
<b>Option blow back RS with solenoid valve and 3-way ball valve 3VA</b>				
SP3000/RS/3VA	II 1 D / 2 GD	<130 [266 °F]	T4	135 [275 °F]
	II 1 D / 2 GD	<185 [365 °F]	T3	190 [374 °F]
Option 2X second sample outlet, possible for every version.				
Option MS1 pneumatic drive implies at least temperature class T4.				
Option HEX4-135 implies at least temperature class T4.				
Option HEX4-180 implies at least temperature class T3.				

**Table 1 Marking for gas sampling from processes with combustible dusts**

## 8.2 SP3100 (COMBUSTIBLE GASES)

The gas sample probes of the type **SP3100** and **SP3100V** are suitable for gas sampling from potentially explosive atmospheres in Zone 0 resp. 1 (combustible gases). They differentiate only in the material of the gaskets for the filter housing.

The version **SP3100** has a gasket out of graphite for probe types heated up to more than 185 °C [365 °F]. The version **SP3100V** has a gasket out of Viton for probe types non-heated or heated up to max. 185 °C [365 °F].

The probe housing and all options are designed for use in potentially explosive atmospheres in Zone 1 or 21 (combustible dusts or combustible gases). The markings can be found in the following table.

The maximum surface temperature of the gas sample probe is depending on the process media temperature and the used options (blow back unit RS, ball valve drive MS1 and probe heating HEX4).

The permissible process media temperatures must not exceed 185 °C for the options filter housing seal Viton® V, 2-way ball valve VA and 3/2-way ball valve 3 VA. For variants without these last-mentioned options, 200 °C must not be exceeded. The resulting maximum surface temperatures and the resulting temperature classes of the gases are shown in Table 2.



The intended use limits the process media temperature and the choice of options insofar as the maximum surface temperature has to be below the limit temperature of the flammable process dust mentioned in Table 7 resp. it has to correspond to the temperature class of the flammable process gases.

SP3100 for sampling from zone 0 resp. 1 flammable gases									
Type	Ex-marking	Max. process-media temperature	T-class	Max. surface temperature	Type	Ex-marking	Max. process media temperature	T-class	Max. surface temperature
<b>SP3100 with graphite sealing</b>					<b>SP3100/V with Viton sealing</b>				
SP3100	II 1 G / 2 GD	< 68 [154.4 °F]	T6	85 [185 °F]	SP3100/V	II 1 G / 2 GD	< 68 [154.4 °F]	T6	85 [185 °F]
	II 1 G / 2 GD	< 80 [176 °F]	T5	100 [212 °F]		II 1 G / 2 GD	< 80 [176 °F]	T5	100 [212 °F]
	II 1 G / 2 GD	< 108 [226.4 °F]	T4	135 [275 °F]		II 1 G / 2 GD	< 108 [226.4 °F]	T4	135 [275 °F]
	II 1 G / 2 GD	< 160 [320 °F]	T3	200 [392 °F]		II 1 G / 2 GD	< 160 [320 °F]	T3	200 [392 °F]
	II 1 G / 2 GD	< 200 [392 °F]	T2	250 [482 °F]		II 1 G / 2 GD	< 185 [365 °F]	T2	232 [449.6 °F]
<b>Blow back RS with solenoid valve</b>									
SP3100/RS	II 2 G / 2 GD	< 130 [266 °F]	T4	135 [275 °F]	SP3100/V/RS	II 2 G / 2 GD	< 130 [266 °F]	T4	135 [275 °F]
	II 2 G / 2 GD	< 195 [383 °F]	T3	200 [392 °F]		II 2 G / 2 GD	< 185 [365 °F]	T3	190 [374 °F]
	II 2 G / 2 GD	< 200 [392 °F]	T2	205 [401 °F]					

2-way ball valve VA									
SP3100/V A (Option MS1 pneumatic drive implies at least temperatur e class T4.)	II 1 G/ 2 GD	< 68 [154.4 °F]	T6	85 [185 °F]	SP3100/V/V A (Option MS1 pneumatic drive implies at least temperature class T4.)	II 1 G/ 2 GD	< 68 [154.4 °F]	T6	85 [185 °F]
	II 1 G/ 2 GD	< 80 [176 °F]	T5	100 [212 °F]		II 1 G/ 2 GD	< 80 [176 °F]	T5	100 [212 °F]
	II 1 G/ 2 GD	< 108 [226.4 °F]	T4	135 [275 °F]		II 1 G/ 2 GD	< 108 [226.4 °F]	T4	135 [275 °F]
	II 1 G/ 2 GD	< 160 [320 °F]	T3	200 [392 °F]		II 1 G/ 2 GD	< 160 [320 °F]	T3	200 [392 °F]
	II 1 G/ 2 GD	< 185 [365 °F]	T2	232 [449.6 °F]		II 1 G/ 2 GD	< 185 [365 °F]	T2	232 [449.6 °F]
3-way ball valve 3VA									
SP3100/3 VA (Option MS1 pneumatic drive implies at least temperatur e class T4.)	II 2 G/ 2 GD	< 80 [176 °F]	T6	85 [185 °F]	SP3100/V/3 VA (Option MS1 pneumatic drive implies at least temperature class T4.)	II 2 G/ 2 GD	< 80 [176 °F]	T6	85 [185 °F]
	II 2 G/ 2 GD	< 95 [203 °F]	T5	100 [212 °F]		II 2 G/ 2 GD	< 95 [203 °F]	T5	100 [212 °F]
	II 2 G/ 2 GD	< 130 [266 °F]	T4	135 [275 °F]		II 2 G/ 2 GD	< 130 [266 °F]	T4	135 [275 °F]
	II 2 G/ 2 GD	< 185 [365 °F]	T3	190 [374 °F]		II 2 G/ 2 GD	< 185 [365 °F]	T3	190 [374 °F]
Blow back RS with solenoid valve and 2-way ball valve VA									
SP3100/R S/VA	II 2 G/ 2 GD	< 130 [266 °F]	T4	135 [275 °F]	SP3100/V/R S/VA	II 2 G/ 2 GD	< 130 [266 °F]	T4	135 [275 °F]
	II 2 G/ 2 GD	< 185 [365 °F]	T3	190 [374 °F]		II 2 G/ 2 GD	< 185 [365 °F]	T3	190 [374 °F]
Blow back RS with solenoid valve and 3-way ball valve 3VA									
SP3100/R S/3VA	II 2 G/ 2 GD	< 130 [266 °F]	T4	135 [275 °F]	SP3100/V/R S/3VA	II 2 G/ 2 GD	< 130 [266 °F]	T4	135 [275 °F]
	II 2 G/ 2 GD	< 185 [365 °F]	T3	190 [374 °F]		II 2 G/ 2 GD	< 185 [365 °F]	T3	190 [374 °F]
Option 2X second sample gas outletzweiter Messgasausgang possible for every version.									
Option FW spun glass possible for every version.									
Option MS1 pneumatic drive Drehantrieb implies at least temperature class T4.									
Option HEX4-135 implies at least temperature class T4.									
Option HEX4-180 implies at least temperature class T3.									

**Table 2 Marking for gas sampling from processes with combustible gases**

### 8.3 SAMPLE TUBES AND PRE-FILTERS FOR THE SP3000

The gas sample probe **SP3000** has a two-stage filter system:

#### 1. In-situ preliminary filter

Various filter materials are available for this filter. The material is selected on the basis of the quality of the dust at the sampling point.



For a valid Ex-approval according to ATEX, only operate the probe SP3000 with one of the pre-filters from Table 3.

## 2. Filter in filter holder part

This large filter element is made of stainless steel or a ceramic. The seals are made of graphite or Viton. The housing is made of anodised aluminium.

The filter system is suitable for dusts with a fineness of up to 2  $\mu\text{m}$ .

Behind the filter system, i.e. at the outlet of the gas sample probe, the sample gas is dust-free. This means that in the absence of explosive sample gas downstream analysers can be used without any special protective measures.

The following figure shows the basic version of the gas sample probe **SP3000/SP3100(V)**.

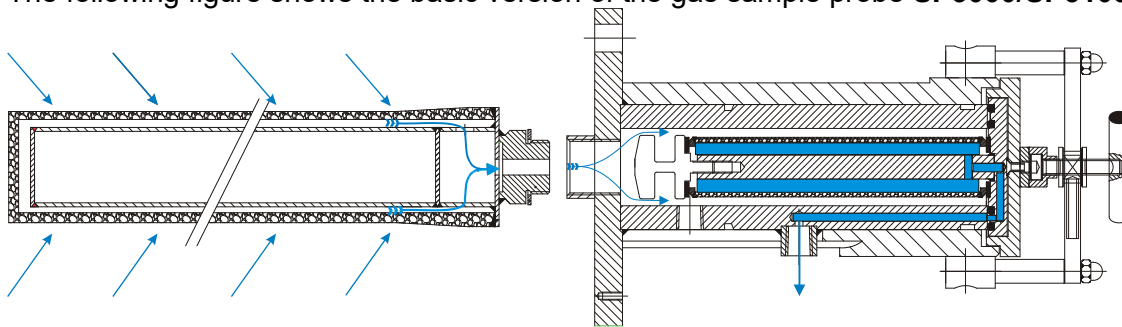

**Figure 1 Probes SP3000/3100(V) without options with preliminary filter type V20**

The filter system of the gas sample probe **SP3000** consists of a process-side preliminary filter and a stainless steel filter element in the probe.

A preliminary filter from the table below must always be selected when using the probe at sampling points with explosive atmosphere due to combustible dusts.

Type	Part No.	Material	Dimensions [mm]	Filter fineness [ $\mu\text{m}$ ]
<b>Filter in the probe:</b>				
S-3 SS150	90F0126	1.4404	150 x 30	2
S-2K150	90S0020	Ceramic Aerolith	150 x 30	2
<b>Probe 3100/FW: (option FW only for SP3100)</b>				
Filter FW (spun glass)	93S2083	Spun glass, high temperature resistant		
<b>Selectable preliminary filters:</b>				
SP2000ST/V20-T	20S9315	PTFE needled felt (antistatic)	450 x 40	3
SP2000ST/V20-0	20S9105	1.4404	200 x 50	3
SP2000ST/V20-0/HC	20S9115	Hastelloy <sup>®</sup> x	200 x 50	3
SP2000ST/V20-1	20S9145	1.4404	500 x 60	3
SP2000ST/V20-1/HC	20S9155	Hastelloy <sup>®</sup> x	500 x 60	3
SP2000ST/V20-1/HC 0.5 $\mu\text{m}$	20S9156	Hastelloy <sup>®</sup> x	500 x 60	0.5
SP2000ST/V20-3	20S9300	1.4404	1000/300 x 31	3

**Table 3 Possible preliminary filter combinations**

The preliminary filter must be selected with a filter fineness suitable for the quality of the dust. The preliminary filter can be extended with the following extension tubes.

Extension [mm] with volume displacer	Part No.
500	20S9165
1000	20S9170
1500	20S9175

**Table 4 Extension tubes**

## 8.4 SAMPLE TUBES, PRE-FILTERS AND OPTION FW FOR SP3100



Warning



### SP3100 and SP3100V:

If the gas-dust mixture that is to be examined can be classified as potentially explosive because it contains combustible gases, only downstream devices (flowmeters, analyzers) with corresponding marking according to directive **2014/34/EU** may be used.

Suitable explosion isolation with a flame arrester must be established. These operating instructions do not cover any downstream units.

For probe SP3100 also option FW spun glass is available.

For option FW the filter element is dropped, and a spun glass cartridge is mounted at the filter housing lid. This spun glass cartridge is filled with a high temperature resistant spun glass. The option FW is used at sample points with risk of quickly blocking filter surfaces due to tar or sticky substances.

The use of standard filter elements S-3SS150 or S-2K150 is not possible with option FW.

When using the gas sample probe **SP3100** and **SP3100V** at sampling points with explosive atmosphere due to combustible gases, a preliminary filter can be dispensed with. In this case sample tubes according to the following table can be selected.

Sample tube Type	Part No.	Max. temp. °C	Material Tube/ Connection	Length "L1" <sup>1)</sup> mm	Length "L max" mm	Connec-tion thread "G"	Tube ø o/i [mm]	Connec-tion ø o "EM" [mm]
SP2000/SS	20S9065	600 [1112 °F]	Stainless steel 1.4571	1000	2500	G 3/4"o	25/22	37
SP2000/SS-Vm	20S9067	600 [1112 °F]	Stainless steel 1.4571	1000	2500	G 3/4"o	25/06	37
SP2000/HC	20S9090	900 [1652 °F]	Hastelloy® x	1000	2500	G 3/4"o	25/22	37
SP2000/KA	20S9080	1300 [2372 °F]	Kanthal®/1.4571	1000	1500	G 3/4"o	27/20	37
SP2000/IN	20S9077	1100 [2012 °F]	Inconel	1000	2500	G 3/4"o	25/22	37

**Table 5 Sample tubes for use with the probe SP3100 and SP3100V**

Pre-filters and extension tubes from Table 3 and Table 4 are also possible.



## 9 OPTIONS

The following options 9.1 to 9.6 are available for use in potentially explosive atmospheres. Please see Table 1 and Table 2 for the markings for the respective zones (combustible dusts and gases).



**Warning**

Attention must be paid to the operating parameters when selecting options.

### 9.1 BACK PURGING UNIT TYPE RS:

The back purging unit type RS consists of a pressure relief valve, solenoid valve, accumulator, and patented pressure control valve in the probe outlet.

A back purging gas suitable for the sampling point must be selected for back purging.

The back purging pressure must always be higher than the process pressure. This minimum pressure must be monitored at the inlet side of the accumulator with a pressure monitoring switch. If the flush gas pressure drops below the process pressure, the back purging solenoid valve may not be operated.



**Warning**

The maximum permissible pressures of 6 bar may not be exceeded (see technical data, chapter 10).

Do not choose back flush intervals longer than 3 seconds because in case of strong pollution of the pre-filter pressure inside the probe would be rising and then discharging to the analyzer via the patented pressure control valve in the outlet of the probe due to a defined leak rate of this valve.

At sampling points with inerting, back purging must be performed with corresponding inert gas. It must be ensured that the inert gas does not introduce oxygen or combustible gases into the system.

The probe **SP3100** and **SP3100V** with back purging option may not be used for gas sampling from Zone 0.

The cyclical operation of the solenoid valve and monitoring of the back purging pressure must be effected externally. The electrical connection of the solenoid valve must be made in an Ex e connection box.

### 9.2 OPTION 2-WAY BALL VALVE /VA

For any service work, e.g. changing the filter element or cleaning works, the stop valve in the probe inlet is actuated from outside with the turning handle. This becomes necessary e.g. in case of overpressure or in case of toxic gas components.



**Danger**

In case of toxic gas components, the probe must be flushed after shutting off and before opening!

### 9.3 OPTION /3VA FEEDING OF TEST GAS AND BACK PURGING VIA 3/2-WAY BALL VALVE

The 3/2-way ball valve allows both functions “back purging” and “test gas feeding” to be made one after the other. *Only one operation each can be automated via the pneumatic drive and must be specified with the order.*

This kind of gas feeding provides the advantage that during back purging the downstream analyse system is automatically separated from the process, respectively, the probe is automatically separated from the process during test gas feeding. For that reason, you need a lower quantity of test gas as no mixture with the process gas may occur.

For measuring operation, turn ball valve into central position.

For blow back, turn ball valve into the corresponding position.

This means in case of manual operation to turn the handle from the central position to the left side up to the stop.

For test gas feeding, the ball valve has to be turned to the right side up to the stop.

For measuring operation, return the ball valve into the central position.

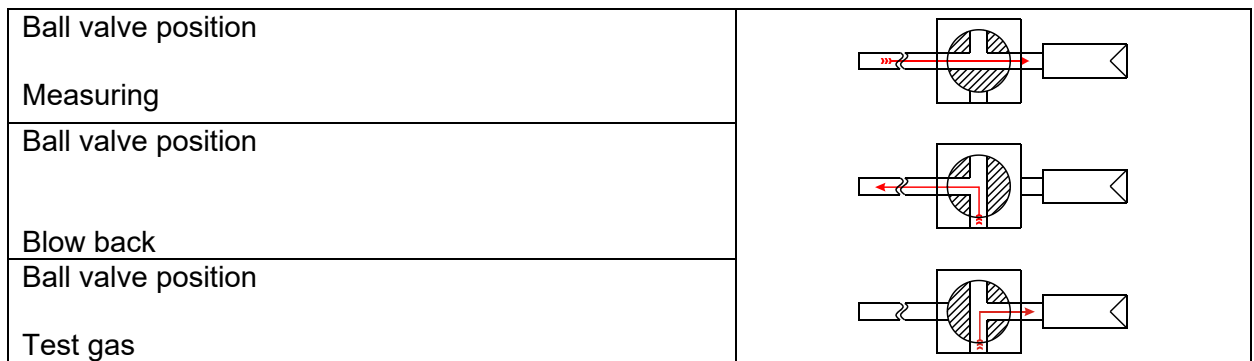

Figure 2 Function schema of option 3/2-way ball valve /3VA

A back purging gas suitable for the sampling point must be selected for back purging. At sampling points with inerting, back purging must be performed with corresponding inert gas. It must be ensured that the inert gas does not introduce oxygen or combustible gases into the system.



The back purging pressure must always be higher than the process pressure. This minimum pressure must be monitored with a pressure switch at the inlet side of the accumulator or the check valve. If the flush gas pressure drops below the process pressure, the back purging solenoid valve must not be operated.

The maximum permissible pressures of 6 bar abs. must not be exceeded (see technical data, chapter 10).

The probes **SP3100** with blow back option or test gas option 3VA must not be used for taking sample from zone 0.



#### 9.4 BALL VALVE DRIVE MS1

The following drives are available:

Pneumatic drive with spring return type **MS/ NC** or **NO**  
Hereby 2 operating conditions can be realized:

a. Using a shut off ball valve VA the conditions:

"Open=measuring" and "shut".

b. Using a 3/2-way ball valve 3VA either the conditions:

"Open=measuring" and "blow back"     **or**

"Open=measuring" and "test gas feeding"

Type **MS-C** for test gas feeding and type **MS-B** for blow back.

When placing the order specify, if the ball valve is

**NC**, (shut without control air), or

**NO**, (open without control air).                     Standard = **NC**

#### 9.5 OPTION /2X SECOND SAMPLE GAS OUTLET ON THE PROBE

With this option, the probe has got two sample gas outlets ¼" NPT i.

#### 9.6 PROBE HEATER

The probe heater type HEX4-.. is designed for two temperature ranges. It consists of a heating plate with two self-regulating heating cartridges, connection box and a weatherproof cover.

Please see the separate operating instructions, Electric Heater Type HEX 4 ..., for the technical data of the heater.

## 10 TECHNICAL DATA

<b>Gas sample probe SP 3000 (combustible dusts)</b>	
<b>Gas sample probe SP 3100(V) (combustible gases)</b>	
Standard mounting flange	DN 65 PN 6
Sampling pressure	0.5 to 6 bar abs.
Material of medium-contacting parts	1.4571, 1.4404 cover gasket graphite (heated up to more than 180 °C [356 °F]) or Viton® (version <b>V</b> , heated up to max. 180 °C [356 °F])
Marking: Gas sample probe SP3000 ( <b>combustible dusts</b> ) Gas sample probe SP3100(V) ( <b>combustible gases</b> )	$\text{Ex}$ II 1 D / 2 GD TX -20°C ≤ T <sub>a</sub> ≤ + 60°C $\text{Ex}$ II 1 G / 2 GD TX -20°C ≤ T <sub>a</sub> ≤ + 60°C or $\text{Ex}$ II 2 G / 2 GD TX -20°C ≤ T <sub>a</sub> ≤ + 55°C (for option back purging unit RS)
Permissible temperature of the medium	The permissible temperature of the medium is limited firstly by the materials used (< 200 °C [392 °F]) and secondly by the maximum permissible surface temperatures given in table 7.
Sample gas outlet connection	1/4" NPT internal, for max. 8 mm tube connections
Sample gas outlet connection with option RS	6 mm Swagelok® connection
<b>Option: Back purging unit type RS</b>	
Power supply back purging unit RS	230 V 50/60 Hz 9 W or 115 V 50/60 Hz 9 W
Electrical connection back purging unit RS	Cable 3 x 1 mm <sup>2</sup>
Marking: Back purging unit RS	$\text{Ex}$ II 2 GD EEx m II 135°C
Connection back purging unit option RS	1/2" at accumulator
Maximum back purging pressure	6 bar abs.
Ambient temperature	-20 °C to 55 °C [-4 to +131 °F]
<b>Option /VA: 2 way ball valve in the probe inlet</b>	
Operating temperature	-20 °C to + 185 °C [-4 to +365 °F]
<b>Option /3VA: 2/3 way ball valve in the probe inlet</b>	
Connection test gas / blow back gas	6 mm tube
Max. blow back pressure	6 bar abs.
Operating temperature	-20 °C to + 185 °C [-4 to +365 °F]
<b>Option ball valve drives MS1</b>	
Connection control air	G 1/4"
Control air	4 to 8 bar

Table 6 Technical data

## 10.1 MAXIMUM SURFACE TEMPERATURE OF THE GAS SAMPLE PROBE

The maximum surface temperature of the gas sample probe depends on the temperature of the process media and the options used (solenoid valve).

The permissible process media temperatures are not allowed to exceed 185 °C [365 °F] at options filter housing sealing Viton® V, 2-way-ball-valve VA and 3/2-way-ball-valve 3VA.



For the other variants 200 °C [392 °F] must not be exceeded.

The resultant maximum surface temperatures and inferable temperature classes of the gases are shown in the following table.

The intended use limits the process media temperature and the choice of options insofar as the maximum surface temperature has to be below the limit temperature of the flammable process dust mentioned in Table 7 resp. it has to correspond to the temperature class of the flammable process gases.

## 11 RECEIPT AND STORAGE

- The probe and any special accessories should be unpacked carefully immediately upon delivery and checked against the delivery note for completeness.
- The delivery should be checked for transport damage and the transport insurer notified immediately of any damage.
- The gas sample probe is usually delivered in two packages:
  - Gas sample probe with the necessary fastening bolts, nuts and flange gasket.
  - Sample tube or preliminary filter – possibly with extension tube.



**Note**

The probe should be stored in a room protected from frost!

## 12 PREPARATIONS FOR INSTALLATION

First make sure that conditions at the intended place of use correspond to the data on the rating plate.

The temperature of the process must be taken into account when selecting the sampling point.

Heating of the probe or preliminary filter above the temperature limit given in Table 7 must be prevented.

**It must be ensured that the temperature limit for the combustible dusts according to Table 7 lies above the maximum surface temperature of the probe because it cannot be ruled out that dust deposits will form in the gas sample probe and preliminary filter.**

The layer thickness of the dust deposits may have a maximum of 5 mm [ $\approx 0.2''$ ]. If dust deposits  $> 5$  mm [ $\approx 0.2''$ ] are formed, the safety distance of the minimum ignition temperature of deposit dust to the maximum surface temperature has to be increased.

The requirements according to DIN EN 60079-14 in its current version must be observed.



Warning

**It must be ensured that the temperature class of the probe corresponds to the ignition temperatures of the combustible gases/vapours.**



Select the optimum sampling point in accordance with general guidelines or agree on a sampling point with the responsible authorities.

Place the sampling point such a way that there is sufficient space for installation and removal of the probe. Do not forget to include the insertion length of the sample tube in your considerations.

Easy access to the probe must be ensured to facilitate later maintenance work.

The customer-side sample nozzle should be dimensioned so that the temperature of the nozzle is always above the process dew point to prevent corrosion and blockages.

If the ambient temperature in the nozzle area is higher than the maximum ambient temperature specified on the type plate due to radiant heat, a radiant heat reflection plate must be installed on site to protect the probe.

The mounting flange connection for the nozzle should be DN 65 PN 6. If another connection size is wanted, an optional intermediate flange adapter **/SO10** is available.

The necessary minimum flange size or minimum nozzle diameter depends on the diameter of the sample tube or preliminary filter used.



The prevailing operating parameters must be checked against the following table prior to installation:

**Operating parameters for sampling point:** .....

<b>Operating parameters for combustible dust (SP3000)</b>			
Ignition temperature of the dust per EN 50281-2-1:1998-09	..... °C Method <b>A</b> (layer)	..... °C Method <b>B</b> (cloud)	Limit temperature corresponds to smallest value from <b>A</b> -75 [°C] and 2/3 x <b>B</b> [°C] ..... (> max. surface temperature from Table 7)
Conductive dust	Yes	No	
Zone classification process side			
Zone classification environment			
Dust composition – smallest particle size > 2 µm		µm	
Dust load		g/m <sup>3</sup>	

<b>Operating parameters for combustible gas (SP3100(V))</b>			
Gas composition	<input type="checkbox"/> <input type="checkbox"/> Corrosive	<input type="checkbox"/> <input type="checkbox"/> Toxic	<input type="checkbox"/> <input type="checkbox"/> Explosive
Zone classification process side			
Zone classification environment			
Ignition temperature of the gas/vapours	..... .....°C (> max. surface temperature from Table 7)	Corresponds to temperature class	
Explosion group	<input type="checkbox"/> <input type="checkbox"/> IIA	<input type="checkbox"/> <input type="checkbox"/> IIB	<input type="checkbox"/> <input type="checkbox"/> IIC

<b>Process conditions</b>			
Underpressure/Overpressure situation		mbar	mbar
Process temperature	min.	°C,	max. °C,
What parameters should be measured, e.g. O <sub>2</sub> , CO, SO <sub>2</sub> , NOX,...		vol. %	mg/Nm <sup>3</sup>
Required gas flow rate	min.	l/h,	max. l/h,
Necessary T90 time		s	

**Table 7 Operating parameters**

### 13 INSTALLATION

The **M&C** probes **SP3000 / SP3100(V)** were developed for stationary use. With correct selection and installation, they will give many years of trouble-free service with a minimum of maintenance.

We recommend a horizontal mounting position with the sample gas outlet pointing downwards (this is not absolutely essential for proper functioning of the probe). The probe should be installed with an inclination of approximately 10° with respect to the process.



#### Warning

**Qualified personnel** Work on the gas sample probe may only be carried out from **QUALIFIED PERSONNEL** when the process and environment have been declared explosion-free zones, i.e. they are free of explosive atmospheres.



The following procedure is recommended:

- Remove the probe cover after opening the two toggle-type fasteners.

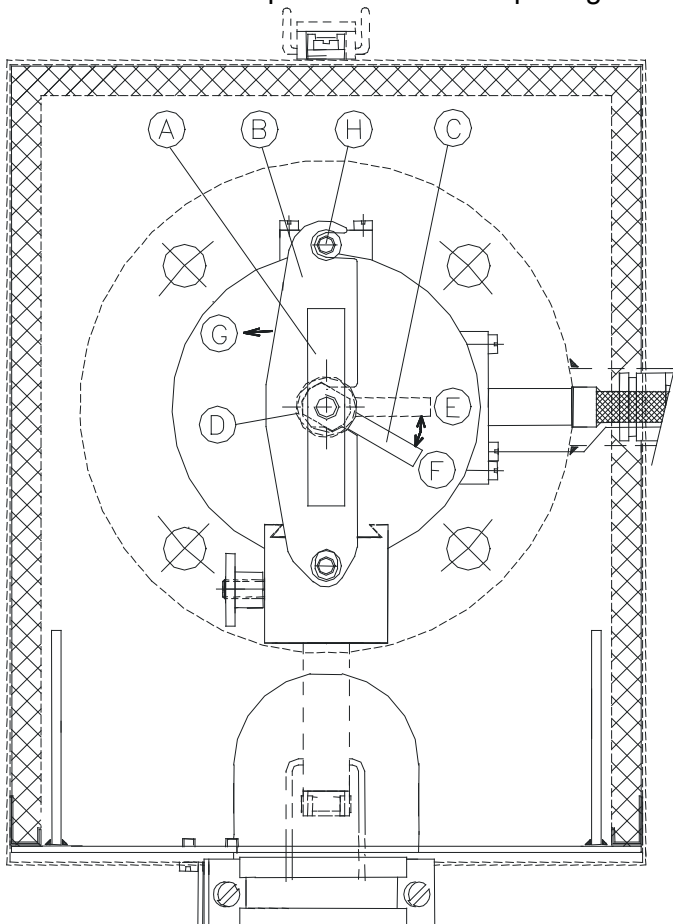

Figure 3 Schematic drawing of the filter housing cover



Turn handle **A** about one full turn anticlockwise so that the cover is lifted.

- Place handle **C** in position **E**.
- Swing out clamp **B** to the left (in the direction of **G**).
- Pull out the filter housing cover with handle **A**.

The following figures illustrate the steps described above.

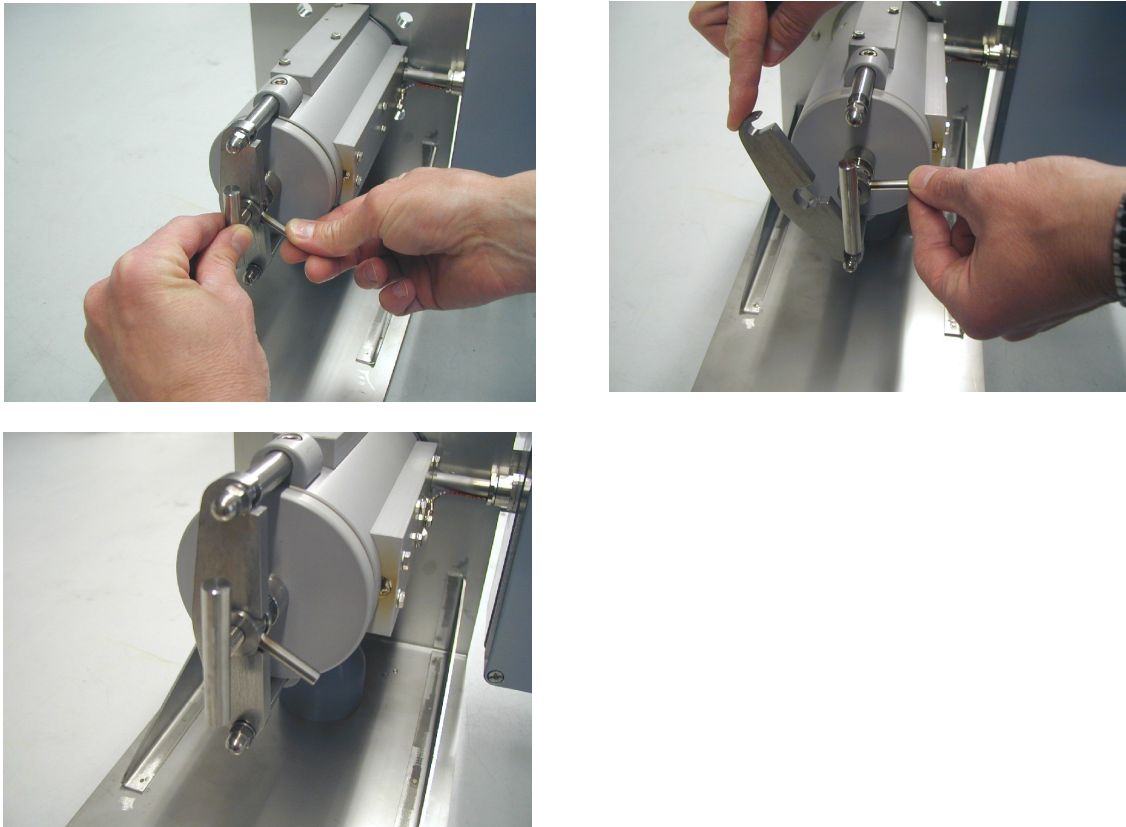

**Figure 4 Removal of the filter housing cover**

- Check that the filter element is screwed on firmly.
- Insert the filter holder part again.

The filter holder part is closed in reverse order.

- Push the  $\frac{3}{4}$ " flat gasket on to the thread of the preliminary filter or extension tube, screw the filter or tube into the  $\frac{3}{4}$ " internal thread in the flange and tighten.

If the sample nozzle does not match the size of the standard flange connection DN 65 PN 6, mount the optional flange adapter delivered on to the probe in the same way.

- Place the flange gasket on to the sample nozzle.
- Insert the complete probe unit into the process-side sample nozzle and screw tight with the nuts and bolts delivered.

### 13.1 CONNECTION OF THE SAMPLE LINE

- A ¼" NPT internal thread is provided on the probe side for connection of the sample line. Suitable connecting unions for explosion-protected lines in the sizes Ø 6 mm (standard), 8 mm or 10 mm can be screwed into this thread using PTFE sealing tape.



The fittings must be tightened carefully to avoid damaging the internal components. The fittings must not be overtightened.

In the event of leaks do not tighten the fittings further. Instead the relevant fitting should be removed completely and then refitted.

Then check the connection for leaks.

The sample line is connected as follows:

- Loosen the toggle-type fasteners on the isolating cover and remove the cover.
- Loosen the thumb screw of the heat conducting plates and remove the plates.
- Screw a suitable union into the probe head using sealing tape.
- Remove the top part of the sample line mounting clamp and insert the sample line through the silicon cap in the bottom part of the bracket plate and up into the union.
- Screw on the top part of the mounting clamp. In the case of larger sample line diameters, it might be necessary for centric mounting of the sample line to move the small mounting bracket of the mounting clamp a little after loosening the two screws and then tighten again.
- Connect the line to the union. For Swagelok® fittings:
  - Insert the line with supporting sleeve fully into the union.
  - Tighten the union nut finger-tight.
  - Before tightening, mark the union nut in 6 o'clock position.
  - Grip the body with a spanner and tighten the union nut by 1¼ turns; after a full turn, the mark must be turned further to 9 o'clock position.
- Then place the heat conducting plates in the guide slots on the side of the sample gas connection and tighten with the thumb screw.



A supporting sleeve must always be used when connecting hose assemblies to stainless steel unions.

The connection must be checked for leaks.

We also recommend the installation of a fine filter in front of the analyzer system.

When using the option back purging unit /RS the corresponding line must be connected to the accumulator.

A back purging gas suitable for the sampling point must be selected for back purging.

The back purging pressure must always be higher than the process pressure. This minimum pressure must be monitored at the inlet side of the accumulator with a pressure monitoring switch. If the flush gas pressure drops below the process pressure, the back purging solenoid valve may not be operated.

At sampling points with inerting, back purging must be performed with corresponding inert gas. It must be ensured that the inert gas does not introduce oxygen or combustible gases into the system.



**Warning** The back purging pressure may not exceed 6 bar abs.

Do not choose back flush intervals longer than 3 seconds because in case of strong pollution of the pre-filter pressure inside the probe would be rising and then discharging to the analyzer via the patented pressure control valve in the outlet of the probe due to a defined leak rate of this valve.

The probe SP3100(V) with back purging option may not be used for gas sampling from Zone 0.

When using the back purging unit on the probe SP3100(V) the marking of the probe is  **Ex II 2 G/ 2 GD**.

- Then refit the cover and fasten with the toggle-type fasteners.

The probe and all options must be earthed. The leak resistance must be  $< 10^6 \Omega$  everywhere.



**Warning**

The function of the probe must be monitored by a flow controller at the downstream analyser. A steady decline in the sample gas flow can be an indication of a need for maintenance work on the probe. The probe must be serviced when the flow rate drops below 50 %.

**Check probe after installation for tightness.**

For option **3VA** connect the suitable tube (blow back or test gas) at the probe.

A back purging gas suitable for the sampling point must be selected for back purging. At sampling points with inerting, back purging must be performed with corresponding inert gas. It must be ensured that the inert gas does not introduce oxygen or combustible gases into the system.



**Warning**

The back purging pressure must always be higher than the process pressure. This minimum pressure must be monitored with a press switch at the inlet side of the accumulator or the check valve. If the flush gas pressure drops below the process pressure, the back purging solenoid valve must not be operated.

The maximum permissible pressures of 6 bar abs. must not be exceeded (see technical data).

The probes **SP3100** and **SP3100V** with blow back option or test gas option 3VA must not be used for taking sample from zone 0.

For option pneumatic ball valve drive **MS1** connect the suitable tube (e.g. control air) at the probe.

The permissible pressures of 3 up to 8 bar are not allowed to be exceeded or to fall below (see technical data, chapter 10).

The used pressure air can be dry or oily.

## 14 ELECTRICAL CONNECTIONS



**Warning**

A wrong supply voltage can damage the device. Make sure that the supply voltage corresponds to the voltage shown on the rating plate before connecting the device.



The requirements of VDE 0100 and its associated standards and regulations must be observed when erecting high-voltage power installations with rated voltages to 1000 V!

In any event we recommend use of heat-resistant cables.



An external main switch must be provided.



The cable of the solenoid valve must be connected in a suitable Ex e connection box.

A fuse suitable for the design current of the solenoid valve (max. 3xIB (operating current) per DIN 41571 or IEC 127) or protective motor switch with short-circuit and thermal rapid release (set on the design current) must be installed in front of the solenoid valve as short circuit protection.



**Warning**



The design voltage of the fuse must be equal to or greater than the specified rated voltage of the solenoid valve. The breaking capacity of the fuse link must be equal to or greater than the maximum conceivable short circuit current at the point of installation (usually 1500 A). The fuse value is specified on the magnet

**Fuse:**

**0.1 A for 230 V/50 Hz**

**0.2 A for 115 V 60 Hz**

**1 A for 24 V**



**Note**

The solenoid valve should be operated cyclically every 60 minutes (carry out min. 1 pulse/s).

## 15 START-UP

The requirements of VDE 0100 and its associated standards and regulations must be observed when erecting high-voltage power installations with rated voltages to 1000 V.



An external main switch must be provided.

The control circuit of the solenoid valve must be protected with a 0.1 A<sub>T</sub> fuse for 230 V/50 Hz, a 0.2 A<sub>T</sub> fuse for 115 V/60 Hz or a 1 A<sub>T</sub> fuse for 24 V.

Make sure that the supply voltage corresponds to the voltage shown on the rating plate before starting the device.

Switch on the power supply.

**Caution**



In ambient temperatures greater than 40 °C [104 °F] the temperature at the protective or isolating cover is higher than 60 °C [140 °F].

## 16 MAINTENANCE



### When working during operation:

High surface temperatures!

Touching the surfaces can result in burns. Wear protective gloves.



Beware of aggressive condensate!



Wear safety goggles and suitable protective clothing.



Warning



The requirements of VDE 0100 and its associated standards and regulations must be observed when erecting and servicing high-voltage power installations with rated voltages to 1000 V!

Work on the gas sample probe may only be carried out when the environment has been declared an explosion-free zone, i.e. it is free of explosive atmospheres.



Warning

The process side must also be declared an explosion-free zone – free of explosive atmospheres – before the filter chamber is opened.



The blow back unit must be switched off before the filter chamber is opened.



The gas sample probe with preliminary filter and internal filter must be checked for temperature and dust deposits at suitable intervals in time depending on the process conditions. Dust layers thicker than 5 mm [0.2"] must be removed immediately. The filters must be checked for damage and replaced if necessary. Also remove the dust deposits under the cover.

The probe must be shut down when the respective maximum surface temperature is exceeded.

The system and process-specific safety measures must be observed for all maintenance work.

Maintenance intervals cannot be recommended. They must be determined on site depending on the specific application and process conditions. One indication of a need for maintenance work on the probe can be a steady decline in the sample gas flow to the analyser system.

Check the probe every 3 years latest.

The testing steps are described as follows.

## 16.1 REPLACEMENT OF THE FILTER ELEMENT

Maintenance of the probe is limited mainly to replacement of the filter elements and inspection of the seals and gaskets. To this:

For probes with graphite sealing the lid sealing has to be changed whenever the probe is opened.  
Probes Sp3xxx/V have O-ring sealings which have to be changed only in case of damage or embrittlement.



**Warning**

Necessary spare parts (1pc. each).  
Graphite sealing M&C part no.:93S0030

O-ring for probes Sp3xxx/V  
O-ring (39) Part No. 93S0020  
O-ring (55) Part No. 93S0025

- Remove the protective cover after opening the toggle-type fasteners.
- Dismount the filter holder part (see Figure 3).
- Unscrew the filter thumb screw and replace the filter element.
- Inspect the filter element seals and replace if necessary.
- Inspect the flat graphite or the Viton<sup>®</sup> O-ring gasket in the cover and replace if necessary.
- Clean the filter chamber.
- Insert the filter holder part again and tighten hand-tight.
- Fit the protective cover.
- **Check tightness of the probe after each opening**

## 16.2 REPLACEMENT OF THE PRELIMINARY FILTER

The complete probe unit must be removed from the process before replacing the preliminary filter. The preliminary filter can, depending on the type and degree of contamination, be cleaned mechanically or in an ultrasonic bath and is then reusable.

## 16.3 BLOW BACK OPTION RS

For probes with option RS function and tightness of the solenoid valve and the non-return valve have to be checked.

## 16.4 BALL VALVE VA OR 3VA

For probes with option ball valve function and tightness of the ball valve have to be checked. Also grounding resp. the copper band at the driving shaft has to be checked for proper condition.

## 16.5 BALL VALVE DRIVE MS1

For probes with option ball valve drive function and tightness of the drive have to be checked.

## 16.6 CLEANING OF THE PROBE

The gas sample probe must be inspected at suitable intervals in time. Dust layers thicker than 5 mm [0.2"] must be removed immediately. The dust deposits under the cover must also be removed.



To prevent static charging, the probe should always be cleaned with a moist cloth.

## 17 SHUTDOWN

Before shutdown, i.e. switching off the heater, the probe should be flushed with a suitable inert gas to prevent condensation of aggressive components of the process gas.

## 18 PROPER DISPOSAL OF THE DEVICE

At the end of the service life of our products, it is important to take care of the appropriate disposal of obsolete electrical and non-electrical devices. To help protect our environment, follow the rules and regulations of your country regarding recycling and waste management.



## 19 APPENDIX

- Probe SP3100(V) with options  
Drawing no.: 2467 – 1.04.0
- EC-Type Examination Certificate (English translation)  
**BVS 04 ATEX H 045 X**
- Dimensions



Further product documentation can be found in and downloaded from our online catalogue at [www.mc-techgroup.com](http://www.mc-techgroup.com)

Zone 0 ↔ Zone 1

Process side **Zone 0** with Option: HEX4-135 T3  
HEX4-180 T2

**Zone 1**

RS and Hex4-135 T4  
RS and/or Hex4-180 T3

1

Sp3100  
Part.No 2055600

Zone 1/21 T4

Part.No 2055600

drawn without cover

2

Safety valve  
Part 2055560

Pressure control valve  
Part 205560A

Option RS  
135°C Part. No. 2055560

Zone 1/21 T4

Option HEX3-1  
not yet available

7

Option HEX4-135 Zone 1/21 T4  
Option HEX4-180 Zone 1/21 T3

135°C Part No. 2055510  
180°C Part No. 2055520

Heating cartridge

5-6

Option HEX1-3 Zone 1 T3  
230V MP Part No. 2059037

4

Hazardous area Zone 1

Non-hazardous area Zone 1

Option HEX1-1 Zone 1 T3  
230V MP Part No. 2059036  
115V MP Part No. 2059036A

3

Option Extension pipes

all prefilters can be extended with:

500mm Extension	Part. 2059165	1.4571
1000mm Extension	Part. 2059170	1.4571
1500mm Extension	Part. 2059175	1.4571

Option smooth Extension pipes

SP2000/SS	Part.2059063	Lq.600	stainl. steel	1.4571	1000
SP2000/SS-Vm	Part.2059067	Lq.600	stainl. steel	1.4571	1000
SP2000/HC	Part.2059090	Lq.900	Hastelloy C4	1000	
SP2000/KA	Part.2059060	Lq.1300	Kenital	1.4571	1000
SP2000/C	Part.2059072	Lq.1200	Incoloy 956	1000	

7	HEK3-1	-	-	-	-
6	HEK4-180	2055520	-	-	-
5	HEK4-135	2055510	-	-	-
4	HEK1-3	2059037	-	-	-
3	HEK1-1	2059036	-	-	-
2	Block flush RS	2055560	1.4571	2467-3.03.0	
1	Probe SP3000	2055600	1.4571-AL	2467-3.01.0	
Pos./Benennung		Art. Nr.		Zehr.-Nr.	

Maße ohne Toleranzangabe nach DIN 7188 m	Überlappung nach DIN ISO 1101	Maßstab 1:4	Art.-Nr.:
Formst. 2	Formst. 2	Werkstoff	%
Datum	Norme	Benennung	
Bezir. 22.08.04 Ge.		SP3100 for sampling out of Zone 0/1	
Gebr.		Zählung-Nr.	2467-1.04.0
Norm		(Ers.):	
		(Ers.):	
		Blatt	
		B.	

Zust.	Änderung	Datum	Name	(Urspr.)

© M&C Verfertigung, auch auszugsweise, ohne Genehmigung von M&C verboten.







TRANSLATION



## (1) EC-Type Examination Certificate

- (2) **- Directive 94/9/EC -**  
**Equipment and protective systems intended for use**  
**in potentially explosive atmospheres**
- (3) **BVS 04 ATEX H 045 X**
- (4) **Equipment:** Gas extraction probe series SP with the versions SP3000 and SP3100 with selectable preliminary filters and optional rewinding unit
- (5) **Manufacturer:** M & C Products Analysentechnik GmbH
- (6) **Address:** Rehhecke 79  
40885 Ratingen  
Germany
- (7) The design and construction of this equipment and any acceptable variation thereto are specified in the schedule to this type examination certificate.
- (8) The certification body of EXAM BBG Prüf- und Zertifizier GmbH certifies that this equipment has been found to comply with the Essential Health and Safety Requirements relating to the design and construction of equipment and protective systems intended for use in potentially explosive atmospheres, given in Annex II to the Directive.  
The examination and test results are recorded in the test and assessment report BVS PP 1100/068/04 EG.
- (9) The Essential Health and Safety Requirements are assured by compliance with:  
DIN EN 1127-1:1997-10, Potentially explosive atmosphere, Explosion protection, Part 1: Basic principles and methodology,  
DIN EN 13463-1:2002-04, Non-electrical equipment for use in potentially explosive areas, Part 1: Basic principles and requirements,  
DIN EN 13463-1 Correction 1:2003-06, Corrections of DIN EN 13463-1:2002-04 and  
BGR 132: Prevention of ignition risks due to electrostatic charging, March 2003.
- (10) If the sign "X" is placed after the certificate number, it indicates that the equipment is subject to special conditions for safe use specified in the schedule to this certificate.
- (11) This EC-Type Examination Certificate relates only to the design, examination and tests of the specified equipment in accordance to Directive 94/9/EC.  
Further requirements of the Directive apply to the manufacturing process and supply of this equipment. These are not covered by this certificate.
- (12) The marking of the equipment shall include the following:

SP3000		II 1 D / 2 GD	- 20 °C ≤ T <sub>a</sub> ≤ + 60 °C
SP3000/RS		II 1 D / 2 GD	- 20 °C ≤ T <sub>a</sub> ≤ + 60 °C
SP3100		II 1 G / 2 GD	- 20 °C ≤ T <sub>a</sub> ≤ + 60 °C
SP3100/RS		II 2 G / 2 GD	- 20 °C ≤ T <sub>a</sub> ≤ + 60 °C

**EXAM BBG Prüf- und Zertifizier GmbH**

Bochum, dated 29 September 2004

Signed: Dr Jockers

Signed: Dr Wörsdörfer

\_\_\_\_\_  
Certification body

\_\_\_\_\_  
Special services unit

Page 1 of 5 of BVS 04 ATEX H 045 X  
This certificate may only be reproduced in its entirety and without change.  
Dinnendahlstraße 9, 44809 Bochum, Germany, Phone +49 (0) 201 172-39 47, Fax +49 (0) 201 172-39 48

TRANSLATION



(13)

Appendix to

(14)

## EC-Type Examination Certificate

### BVS 04 ATEX H 045 X

(15) 15.1 Subject and Type

Versions of the gas extraction probe SP3000 for gas extraction from processes with combustible dusts and SP3100 for gas extraction from processes with combustible gases:

SP3000

SP3000/RS with rewinding unit

SP3100

SP3100/RS with rewinding unit

The basic version is the gas extraction probe SP3000 respectively SP3100, which can be extended by the following option:

The rewinding unit type RS for the preliminary filter frit consists of a pressure control valve, a magnetic valve, a pressure accumulator and a pressure-blocking valve in the probe's exit. For the reverse flush, a gas is chosen in accordance with the operation manual. The reverse flush is realised at a pressure of up to 6 bar. The cyclic activation of the magnetic valve is realised with the help of a control that is not part of the EC-Type Examination. The electric connection is realised at a joint box outside of the probe. The joint box is not part of the EC-Type Examination.

The weather protection cover is an isolated sheet steel casing to cover the probe's filter casing.

The following analysis with an adequate flow rate monitoring system is not part of this EC-Type Examination. Adequate analysis systems are to be used, the category of which has to correspond to the service conditions.

#### 15.2 Description

The probes of types SP3000 and SP3100 are used for the continual gas extraction in processes with combustible dusts and gases, process media temperatures of up to 200 °C and a high moisture content.

The gas extraction probe type SP3000 respectively SP3100 is a two-tiered filter system. For the preliminary filter on the process side, various filter materials are available, depending on the quality of the dust at the extraction point. The preliminary filter can be elongated with the help of an extension pipe. The second tier exists of an extensive filter element made from stainless steel or ceramics. The gaskets used are made from graphite or Viton. Die surrounding parts of the casing are made from anodised aluminium.

**Table 2a:** Filter elements

Type	Drawing No. (M & C Products GmbH)	Material	Measures [mm]	Filter fineness [µm]
<b>Filter in the probe:</b>				
S-3 SS150	2200-3.33.0	1.4404	150 x 30	2
S-2K150	2467-4.22.0	Ceramics Aerolith	150 x 30	2

Page 2 of 5 of BVS 04 ATEX H 045 X

This certificate may only be reproduced in its entirety and without change.

Dinnendahlstraße 9, 44809 Bochum, Germany, Phone +49 (0) 201 172-39 47, Fax +49 (0) 201 172-39 48

## TRANSLATION



Selectable preliminary filter:				
SP2000ST/V20-T	2467-4.11.0	PTFE needled felt (antistatic)	450x40	3
SP2000ST/V12-1	2467-4.07.0	Al <sub>2</sub> O <sub>3</sub> /SIC	500x40	3
SP2000ST/V12-3	2467-4.08.0	Al <sub>2</sub> O <sub>3</sub> /SIC	1000x60	3
SP2000ST/V20-0	2467-4.13.0	1.4404	200x50	3
SP2000ST/V20-0/HC	2467-4.13.0	Hastelloy x	200x50	3
SP2000ST/V20-1	2467-4.09.0	1.4404	500x60	3
SP2000ST/V20-1/HC	2467-4.09.0	Hastelloy x	500x60	3
SP2000ST/V20-1/HC 0,5µm	2467-4.09.0	Hastelloy x	500x60	0,5
SP2000ST/V20-3	2467-4.10.0	1.4404	1000/300x31	3

After the filtration at the gas extraction probe's exit, the measuring gas is free of dusts of a particle size of > 2 µm.

When in use at extraction points with potentially explosive atmosphere through combustible gases, a preliminary filter at the gas extraction probe SP3100 can be dispensed with. In this case, extraction pipes can be chosen in accordance with Table 2b.

**Table 2b:** Extraction pipes

Type	Drawing No. (M & C Products GmbH)	Material
SP2000/SS	2246-1.01.0	Stainless steel 1.4571
SP2000/SS-Vm	2246-1.01.0	Stainless steel 1.4571
SP2000/HC	2246-1.01.0	Hastelloy C4
SP2000/KA	2246-1.01.0	Kanthal / 1.4571
SP2000/IC	2246-1.01.0	Incoloy 956

### 15.3 Parameters

The ambient temperature is stated to be -20 °C to + 60 °C.

The admissible extraction pressure is 0,5 bar to 7 bar.

The highest admissible process media temperature is 200 °C.

(16) Test and Assessment Report

BVS PP 1100/068/04 EG, as of 28 September 2004

(17) Special Conditions for Safe Use

The probe may not be used to extract gases or mixtures of gases that are potentially explosive also in the absence of air or that alter the safety relevant material properties. Furthermore, these gases or mixtures of gases may not contain any solids, which might generate ignitable rubbing or striking sparks in combination with the probe's materials.

## TRANSLATION

















The following analysis with an adequate flow rate monitoring system is not part of this EC-Type Examination. Adequate analysis systems are to be used, the category of which has to correspond to the service conditions.

The gas extraction probes SP3000 respectively SP3100 and the reverse flush have to be grounded safely and permanently. The bleeder must have a value of  $< 10^6 \Omega$  against earth.

In the case of version SP3100/RS, the reverse flush pressure must always exceed the process pressure. Therefore, the reverse flush pressure has to be monitored on the pressure accumulator's entry. If the reverse flush pressure falls below the process pressure, the magnetic valve may not be activated.

The probes' maximum surface temperature depends on the temperature of both the process medium and of the electrical devices. The process media temperature is maximally 200 °C (cf. operation manual). The maximum surface temperatures resulting from this as well as the temperature classes of the gases permitted that can be derived from this are to be drawn from table 3:

**Table 3:** Interrelation between version, temperature of the process medium and the maximum surface temperature respectively temperature class for gases

Version	Marking	Maximum process media temperature [°C]	Maximum surface temperature [°C]	Temperature class
SP3000	 II 1 D / 2 GD	≤ 80	80	T6
SP3000	 II 1 D / 2 GD	≤ 95	95	T5
SP3000	 II 1 D / 2 GD	≤ 130	130	T4
SP3000	 II 1 D / 2 GD	≤ 195	195	T3
SP3000/RS	 II 1 D / 2 GD	≤ 130	135	T4
SP3000/RS	 II 1 D / 2 GD	≤ 195	195	T3
SP3000/RS	 II 1 D / 2 GD	≤ 200	200	T2
SP3100	 II 1 G / 2 GD	≤ 68	68	T6
SP3100	 II 1 G / 2 GD	≤ 80	80	T5
SP3100	 II 1 G / 2 GD	≤ 108	108	T4
SP3100	 II 1 G / 2 GD	≤ 160	160	T3
SP3100	 II 1 G / 2 GD	≤ 200	200	T2
SP3100/RS	 II 2 G / 2 GD	≤ 130	135	T4
SP3100/RS	 II 2 G / 2 GD	≤ 195	195	T3
SP3100/RS	 II 2 G / 2 GD	≤ 200	200	T2



TRANSLATION



---

We confirm the correctness of the translation from the German original.  
In the case of arbitration only the German wording shall be valid and binding.

44809 Bochum, Germany, 13 December 2004  
1100/068/04 BVS-Lie/Sa

**EXAM BBG Prüf- und Zertifizier GmbH**

  
Certification body

  
Special services unit

© M&C Vervielfältigung, auch auszugsweise, ohne Genehmigung von M&C verboten

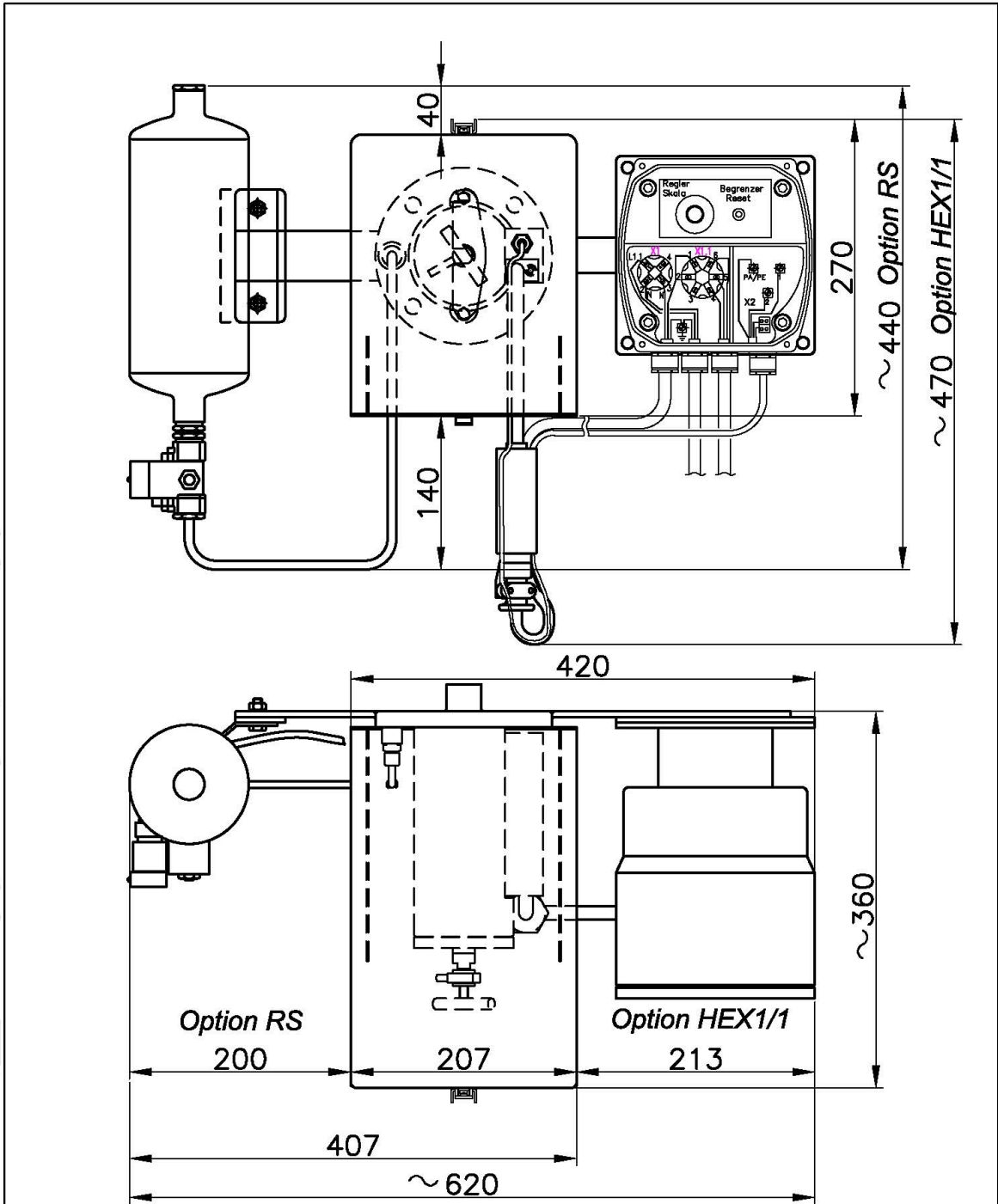

				Maße ohne Toleranzangabe nach DIN 7168 m	Oberflächenzeichen nach DIN ISO 1302 Reihe 2 Format DIN A4 quer	Maßstab 1:5	Art.Nr.:	
					Datum	Werkstoff		
				Bear. 30.11.04	Name	%		
				Gepr.	Ge.	Benennung		
				Norm		Baumaße SP3100 RS, HEX1/1		
				M&C Products Analysetechnik GmbH Rehhecke 79 40885 Ratingen			Zeichnungs-Nr.	Blatt
							2467-1.06.1	
Zust.	Änderung	Datum	Name	(Urspr.)	(Ers.f.:	(Ers.d.:		



© M&C Vervielfältigung, auch auszugsweise, ohne Genehmigung von M&C verboten

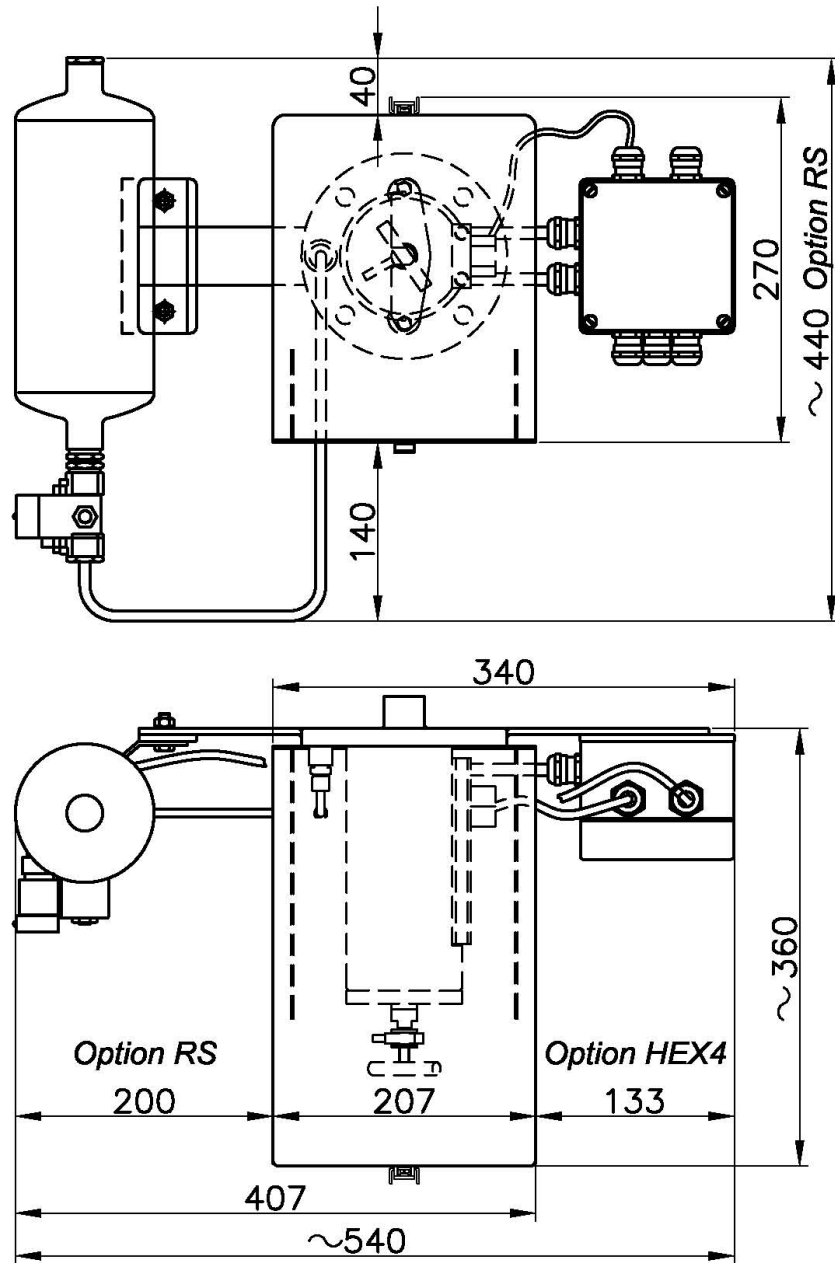

				Maße ohne Toleranzangabe nach DIN 7168 m	Oberflächenzeichen nach DIN ISO 1302 Reihe 2 Format DIN A4 quer	Maßstab 1:5	Art.Nr.:
						Werkstoff	%
				Datum	Name	Benennung	
				Bear. 30.11.04	Ge.	Baumaße SP3000/SP3100 RS, HEX4	
				Gepr.			
				Norm			
				M&C Products Analysentechnik GmbH Rehhecke 79 40885 Ratingen		Zeichnungs-Nr.	Blatt
							2467-1.06.0
Zust.	Änderung	Datum	Name	(Urspr.)	(Ers.f.:	(Ers.d.:	1 Bl.